

Typical Applications

The HMC174MS8 / HMC174MS8E is ideal for:

- ISM Applications
- PCMCIA Wireless Cards
- Portable Wireless

Features

- Ultra Small Package: MSOP8
- High Third Order Intercept: +60 dBm
- Single Positive Supply: +3 to +10V
- High RF power Capability

Functional Diagram

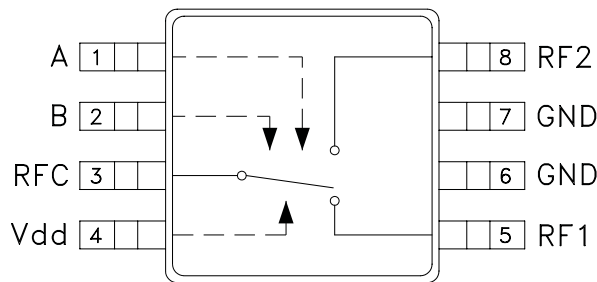

General Description

The HMC174MS8 & HMC174MS8E are low-cost SPDT switches in 8-lead MSOP packages for use in transmit-receive applications which require very low distortion at high signal power levels. The device can control signals from DC to 3.0 GHz and is especially suited for 900 MHz, 1.8 - 2.2 GHz, and 2.4 GHz ISM applications with only 0.5 dB loss. The design provides exceptional intermodulation performance; providing a +60 dBm third order intercept at 8 Volt bias. RF1 and RF2 are reflective shorts when "OFF". On-chip circuitry allows single positive supply operation at very low DC current with control inputs compatible with CMOS and most TTL logic families.

Electrical Specifications, $T_A = +25^\circ C$, $V_{dd} = +5 V_{dc}$, 50 Ohm System

Parameter	Frequency	Min.	Typ.	Max.	Units
Insertion Loss	DC - 1.0 GHz		0.5	0.7	dB
	DC - 2.0 GHz		0.5	0.8	dB
	DC - 2.5 GHz		0.7	1.0	dB
	DC - 3.0 GHz		1.4	1.8	dB
Isolation	DC - 1.0 GHz	22	25		dB
	DC - 2.0 GHz	20	24		dB
	DC - 2.5 GHz	17	21		dB
	DC - 3.0 GHz	13	17		dB
Return Loss	DC - 1.0 GHz	20	28		dB
	DC - 2.0 GHz	16	21		dB
	DC - 2.5 GHz	13	17		dB
	DC - 3.0 GHz	9	11		dB
Input Power for 1dB Compression	0/8V Control	0.5 - 1.0 GHz	35	39	dBm
		0.5 - 3.0 GHz	34	38	dBm
Input Third Order Intercept	0/8V Control	0.5 - 1.0 GHz	55	60	dBm
		0.5 - 3.0 GHz	55	60	dBm
Switching Characteristics	DC - 3.0 GHz				
		tRISE, tFALL (10/90% RF) tON, tOFF (50% CTL to 10/90% RF)		10 24	ns ns



Insertion Loss

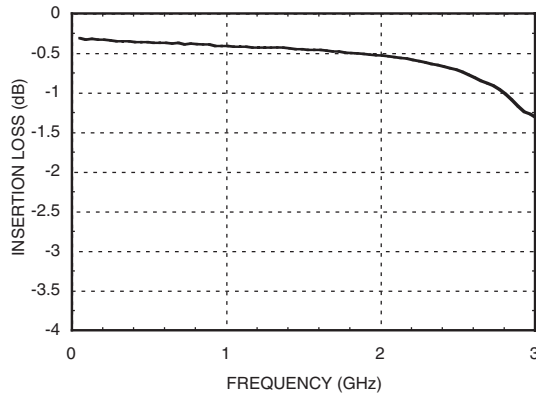

Isolation

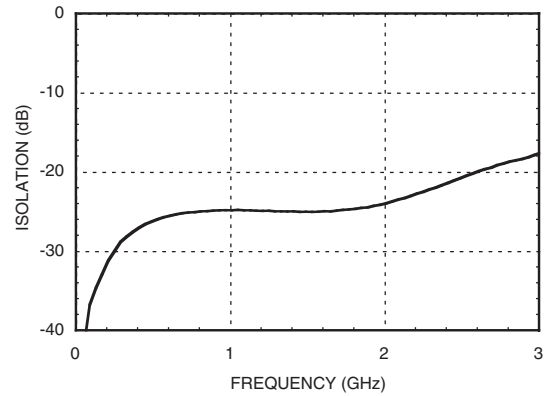

Return Loss

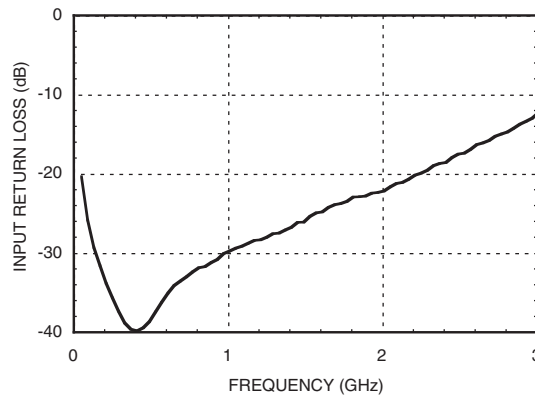

**Input 0.1 and 1.0 dB
Compression vs. Bias Voltage**

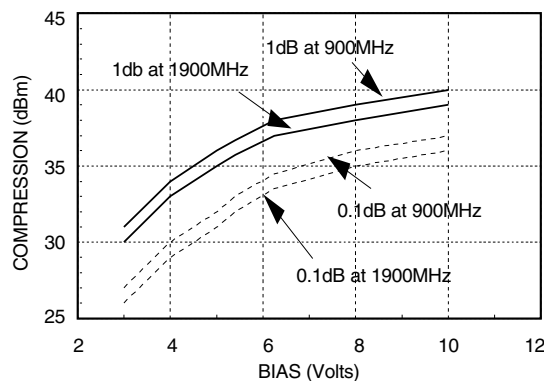

**Input Third Order
Intercept vs. Bias Voltage**

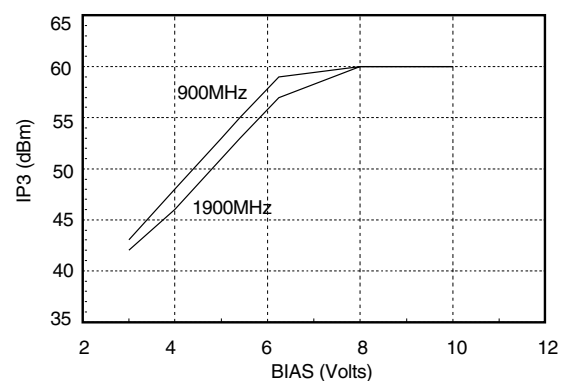



Compression vs. Bias Voltages

Bias V _{dd}	Carrier at 900 MHz		Carrier at 1900 MHz	
	Input Power for 0.1 dB Compression	Input Power for 1.0 dB Compression	Input Power for 0.1 dB Compression	Input Power for 1.0 dB Compression
(Volts)	(dBm)	(dBm)	(dBm)	(dBm)
3	27	31	26	30
4	30	34	29	33
5	32	36	31	35
8	36	39	35	38
10	37	40	36	39

Caution: Do not operate in 1dB compression at power levels above +35dBm and do not 'hot switch' power levels greater than +23dBm ($V_{dd} = +5Vdc$).

Distortion vs. Bias Voltage

Bias V _{dd}	1 Watt Carrier at 900 MHz			1 Watt Carrier at 1900 MHz		
	Third Order Intercept	Second Order Intercept	Second Harmonic	Third Order Intercept	Second Order Intercept	Second Harmonic
(Volts)	(dBm)	(dBm)	(dBc)	(dBm)	(dBm)	(dBc)
3	43	71	45	42	78	55
4	48	85	55	46	88	65
5	53	90	56	51	87	58
8	60	90	58	60	90	59
10	60	90	59	60	90	60

Truth Table

*Control Input Voltage Tolerances are $\pm 0.2 Vdc$

Bias V _{dd} (Vdc)	Control Input*		Bias Current (uA)	Control Current (uA)	Control Current (uA)	Signal Path State	
	A (Vdc)	B (Vdc)				RF to RF1	RF to RF2
3	0	0	30	-15	-15	OFF	OFF
3	0	V _{dd}	25	-25	0	ON	OFF
3	V _{dd}	0	25	0	-25	OFF	ON
5	0	0	110	-55	-55	OFF	OFF
5	0	V _{dd}	115	-100	-15	ON	OFF
5	V _{dd}	0	115	-15	-100	OFF	ON
10	0	0	380	-190	-190	OFF	OFF
10	0	V _{dd}	495	-275	-220	ON	OFF
10	V _{dd}	0	495	-220	-275	OFF	ON
5	-V _{dd}	V _{dd}	600	-600	225	ON	OFF
5	V _{dd}	-V _{dd}	600	225	-600	OFF	ON



Absolute Maximum Ratings

Bias Voltage Range (Vdd)	-0.2 to +12 Vdc
Control Voltage Range (A & B)	-0.2 to +Vdd Vdc
Storage Temperature	-65 to +150 °C
Operating Temperature	-40 to +85 °C
ESD Sensitivity (HBM)	Class 1A



**ELECTROSTATIC SENSITIVE DEVICE
OBSERVE HANDLING PRECAUTIONS**

Outline Drawing

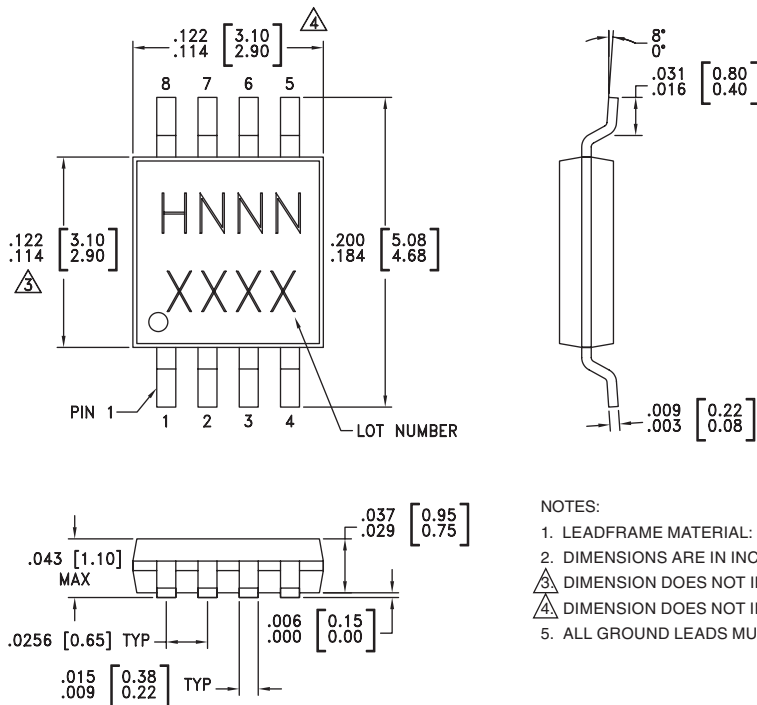

NOTES:

1. LEADFRAME MATERIAL: COPPER ALLOY
2. DIMENSIONS ARE IN INCHES [MILLIMETERS]
- ⚠ DIMENSION DOES NOT INCLUDE MOLDFLASH OF 0.15mm PER SIDE.
- ⚠ DIMENSION DOES NOT INCLUDE MOLDFLASH OF 0.25mm PER SIDE.
5. ALL GROUND LEADS MUST BE SOLDERED TO PCB RF GROUND.

Package Information

Part Number	Package Body Material	Lead Finish	MSL Rating	Package Marking ^[3]
HMC174MS8	Low Stress Injection Molded Plastic	Sn/Pb Solder	MSL1 ^[1]	H174 XXXX
HMC174MS8E	RoHS-compliant Low Stress Injection Molded Plastic	100% matte Sn	MSL1 ^[2]	H174 XXXX

[1] Max peak reflow temperature of 235 °C

[2] Max peak reflow temperature of 260 °C

[3] 4-Digit lot number XXXX

Typical Application Circuit

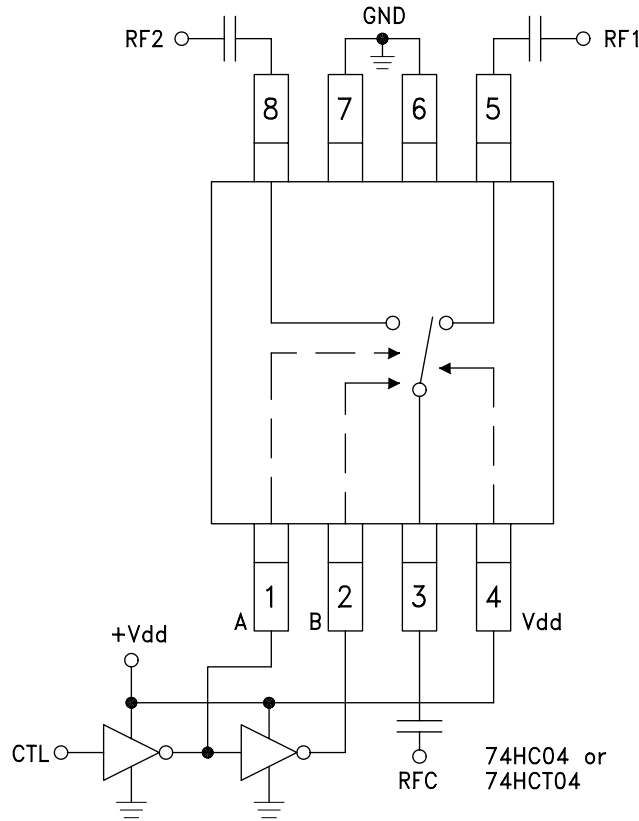

Notes:

1. Set logic gate and switch Vdd = +3V to +5V and use HCT series logic to provide a TTL driver interface.
2. Control inputs A/B can be driven directly with CMOS logic (HC) with Vdd of 3 to 8 Volts applied to the CMOS logic gates and to pin 4 of the RF switch.
3. DC Blocking capacitors are required for each RF port as shown. Capacitor value determines lowest frequency of operation.
4. Highest RF signal power capability is achieved with V set to +10V. The switch will operate properly (but at lower RF power capability) at bias voltages down to +3V.



Evaluation Circuit Board

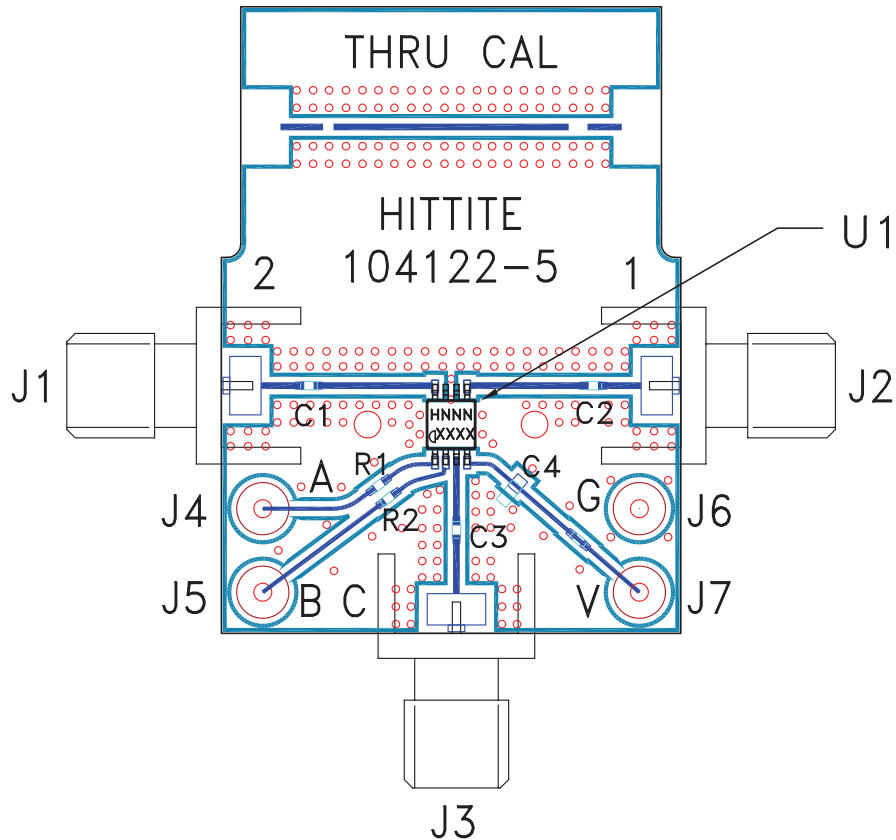

List of Materials for Evaluation PCB 104124 [1]

Item	Description
J1 - J3	PCB Mount SMA RF Connector
J4 - J7	DC Pin
C1 - C3	100 pF capacitor, 0402 Pkg.
C4	10,000 pF capacitor, 0603 Pkg.
U1	HMC174MS8 / HMC174MS8E T/R Switch
PCB [2]	104122 Evaluation PCB

[1] Reference this number when ordering complete evaluation PCB

[2] Circuit Board Material: Rogers 4350

The circuit board used in the final application should be generated with proper RF circuit design techniques. Signal lines at the RF port should have 50 ohm impedance and the package ground leads and package bottom should be connected directly to the ground plane similar to that shown above. The evaluation circuit board shown above is available from Hittite Microwave Corporation upon request.